

GENERAL DATASHEET VARIABLE SPEED DRIVE

Series A510				MODEL# A510-5008-C3-U		
ISSUED 9/6/2016				ENCLOSURE/ FRAME NEMA 1 (IP20) / F3		
INPUT AMPS				AC INPUT VOLTAGE	AC INPUT FREQUENCY	AC INPUT PHASE
HD (CT) 10.9		ND (VT) 13.4				
OUTPUT HP				AC OUTPUT VOLTAGE	AC OUTPUT FREQUENCY	AC OUTPUT PHASE
HD (CT) 7.5		ND (VT) 10				
OUTPUT AMPS				AC OUTPUT VOLTAGE	AC OUTPUT FREQUENCY	AC OUTPUT PHASE
HD (CT) 9.9		ND (VT) 12.2				
				500-600	50/60	3
				500-600	0-599	3

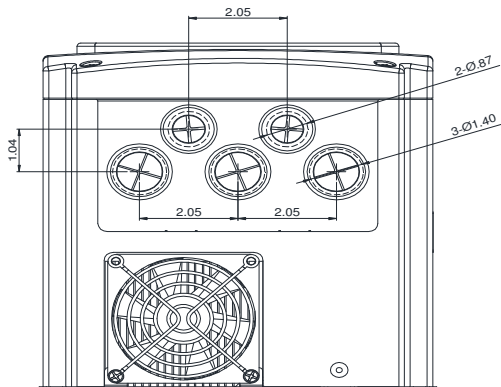
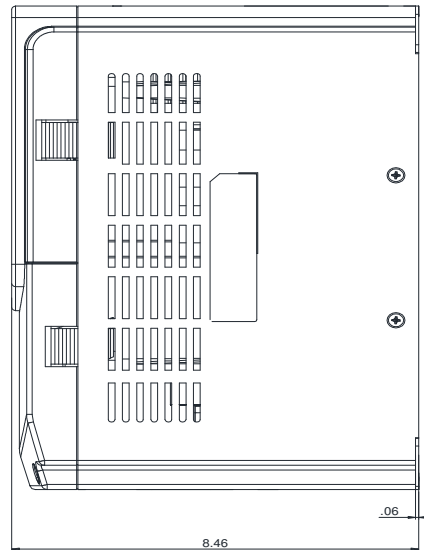
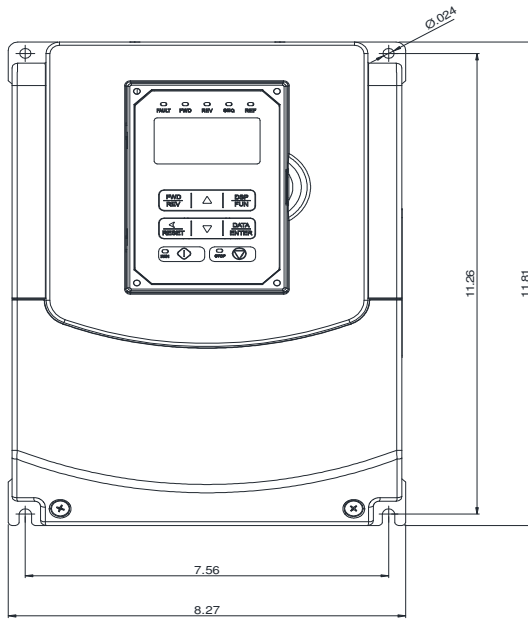

Approved By:	Brian Smith	Drawing No:	A510-575-008-F3	Revision: 0
--------------	-------------	-------------	-----------------	-------------