

510 series copy module instruction manual

1. Dimension of copy unit: (Unit: mm)

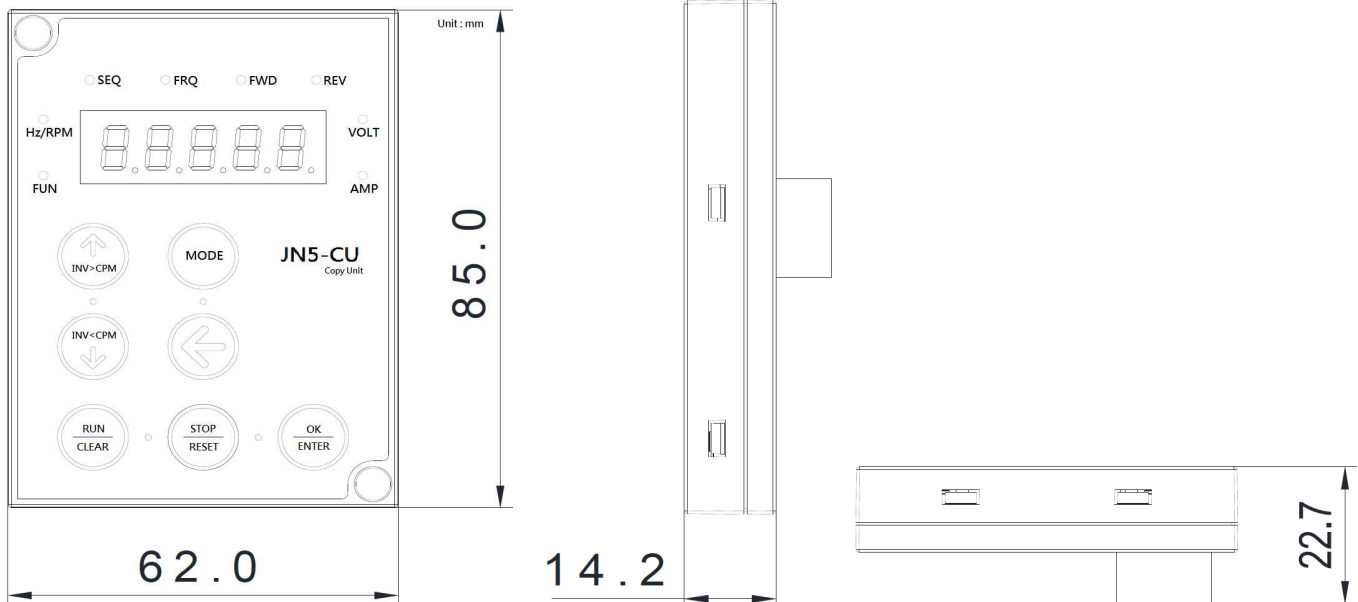

2. Function key instruction:



Function key instruction	
INV>CPM	Upload the data from inverter to copy unit
INV<CPM	Download the data from copy unit to inverter
CLEAR	CLEAR
OK	Confirm
↑ ↓	Change the value
←	Deselected
RESET	Return

Function of keypad	
RUN	Operation command
MODE	Display mode selection
STOP/RESET	1. Stop the inverter 2. Switched to copy unit mode 3. Reset function of inverter
ENTER	Confirm

3. Copy unit instruction:



means the copy unit is waiting to confirm.

Parameter setting of inverter before using copy unit, please set the parameter as below.

Parameter Name	Setting value
(09-00)INV communication station address	1
(09-01)RTU code/ASCII code select	RTU
(09-02)Baud rate setting	19200
(09-03)Stop bit selection	1
(09-04)Parity selection	No parity
(09-05)Data format selection	8 bit

Note:

1. If the parameter setting does not follow the table, keypad displays “**Err0**”.
2. Once inverter needs go into copy unit mode, please stop the inverter first.
3. Please connect the copy unit and inverter as below.
4. Copy unit can be used for firmware version 1.4 above of A510, firmware version 1.0 above of L510/E510

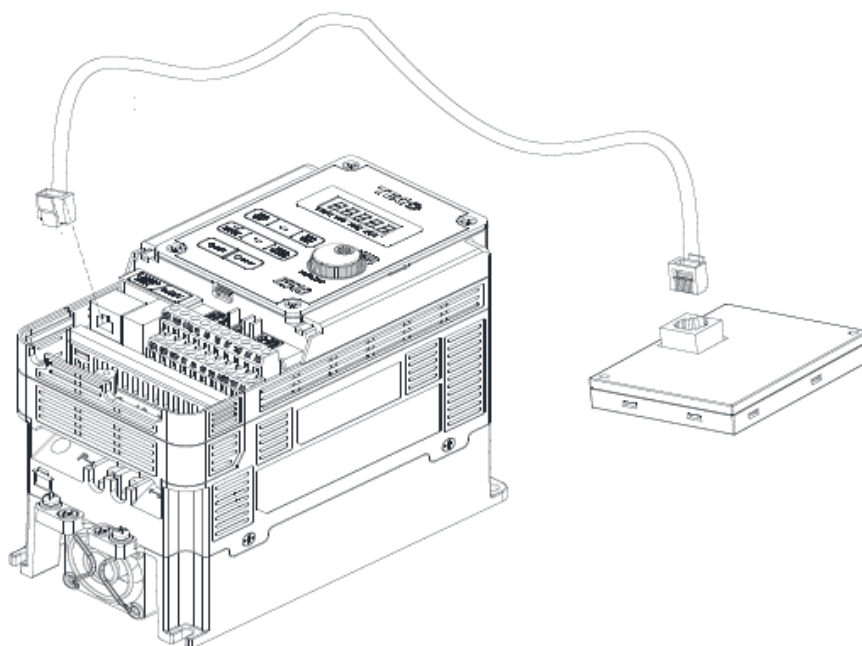

Copy unit connection

3-1. Go into "copy mode"

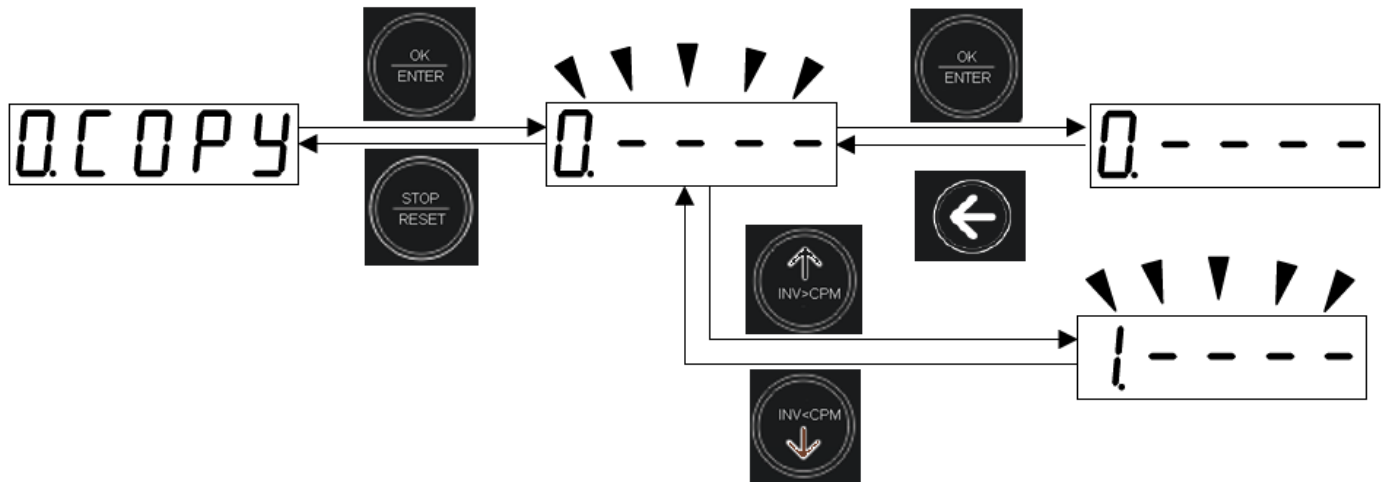

Note: Copy unit can store 4 sets data, number of data is 0 to 3.

3-2. Inverter uploads the parameter to copy unit

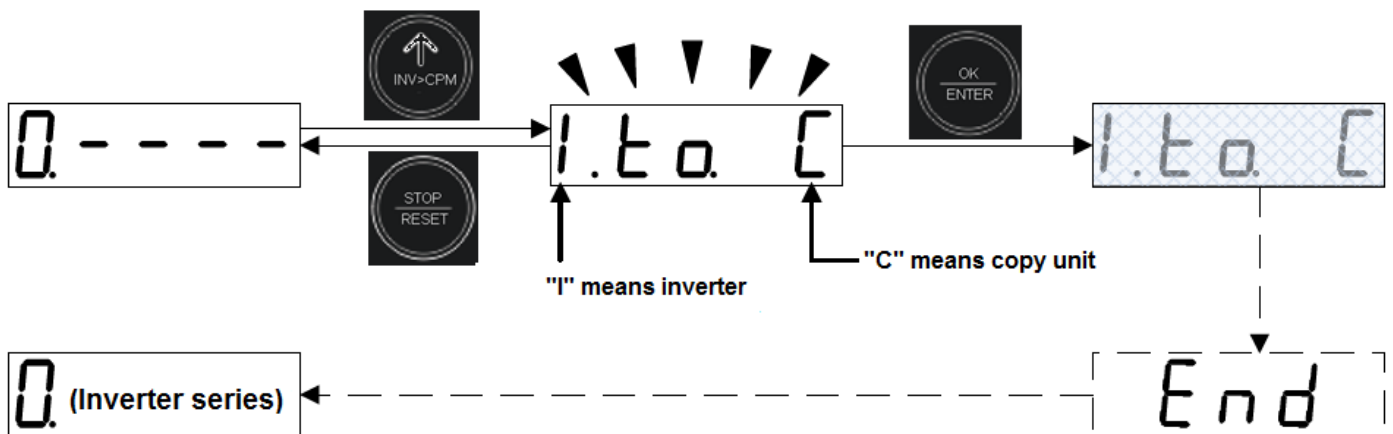

3-3. Inverter downloads the parameter from copy unit

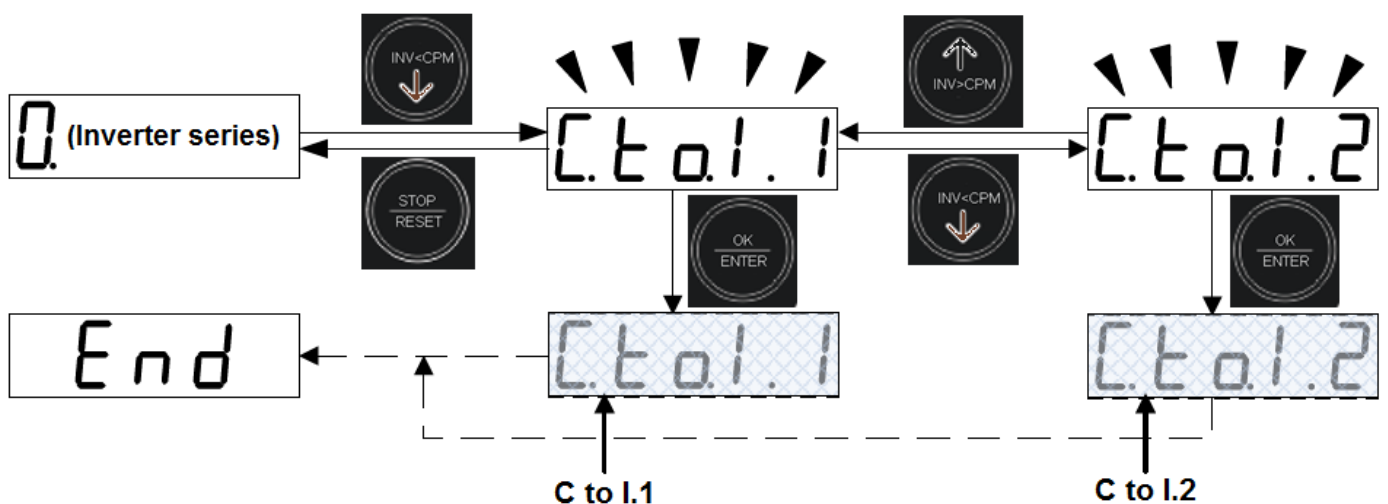

There are two ways of upload the parameter from inverter to copy unit.

1. "C to I.1" means the data including the motor parameter.
2. "C to I.2" means the data does not include the motor parameter.

3-4. Delete the data of copy unit



3-5. Go into "Remote Control Mode"

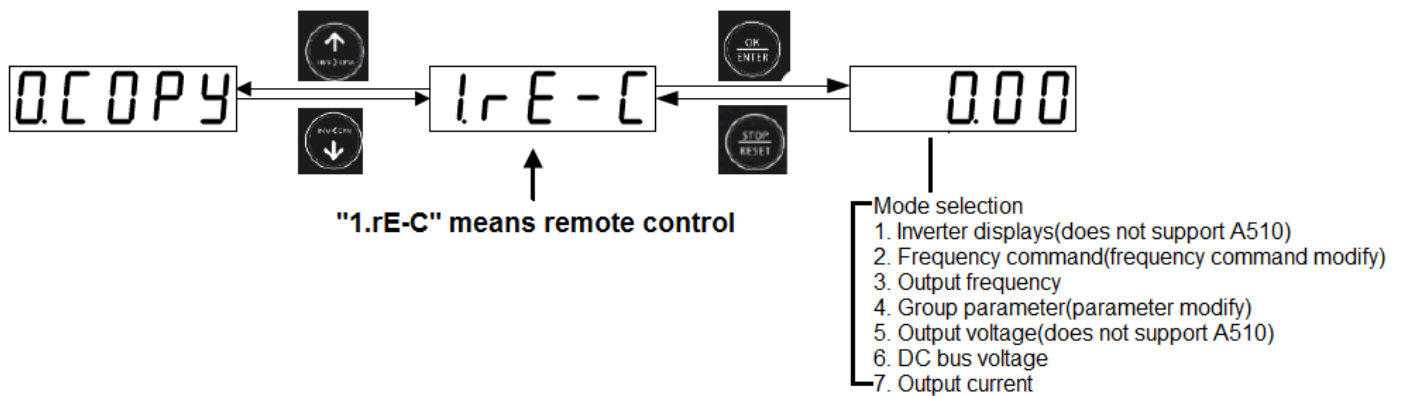

3-5. Check the software version of copy unit

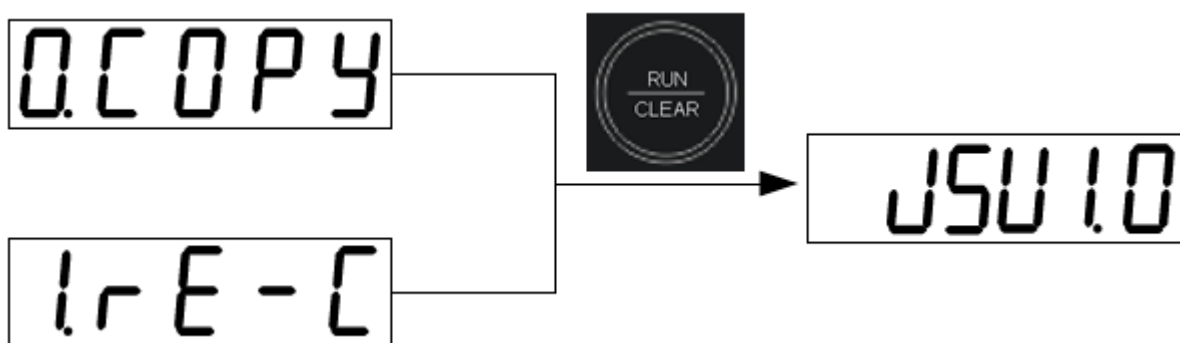

4. Error display and troubleshooting

Display	Error	Cause	Remedy
Err0	Communication error	<ul style="list-style-type: none"> ● Noise interference ● Can not connect with inverter 	<ul style="list-style-type: none"> ● Replace a new inverter ● Check the connection cable ● Repair the copy unit
Err1	No parameter	<ul style="list-style-type: none"> ● No parameter ● Can not write into inverter 	Upload the parameter into copy unit first.
Err2	Parameter check error	Data error caused by interference	-----
Err7	Inverter firmware version does not suitable to use	Firmware version is too old	Update the new version
EPR	EEPROM error	EEPROM error	Replace a new EEPROM
I-err	Communication error of remote control	Communication error of remote control	<ul style="list-style-type: none"> ● Press STOP/RESET key ● Check the slave device