

GENERAL DATASHEET VARIABLE SPEED DRIVE

Series L510		MODEL# L510-201-H3-U	
ISSUED 3/26/2018		ENCLOSURE/ FRAME Chassis (IP20/00)/ F1	
INPUT AMPS HD (CT) 6.4		AC INPUT VOLTAGE 230	AC INPUT FREQUENCY 50/60
AC INPUT PHASE 3			
OUTPUT HP HD (CT) 1	OUTPUT AMPS HD (CT) 4.3	AC OUTPUT VOLTAGE 0-230	AC OUTPUT FREQUENCY 0-599
		AC OUTPUT PHASE 3	

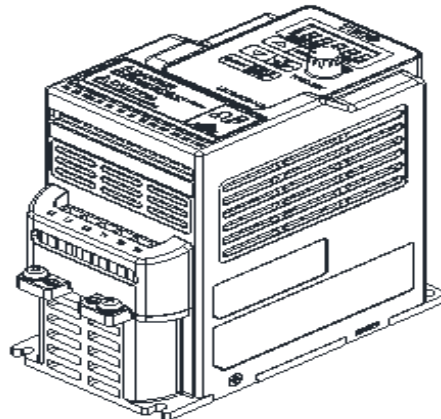
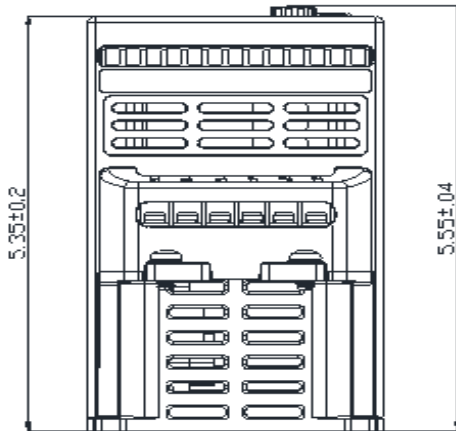
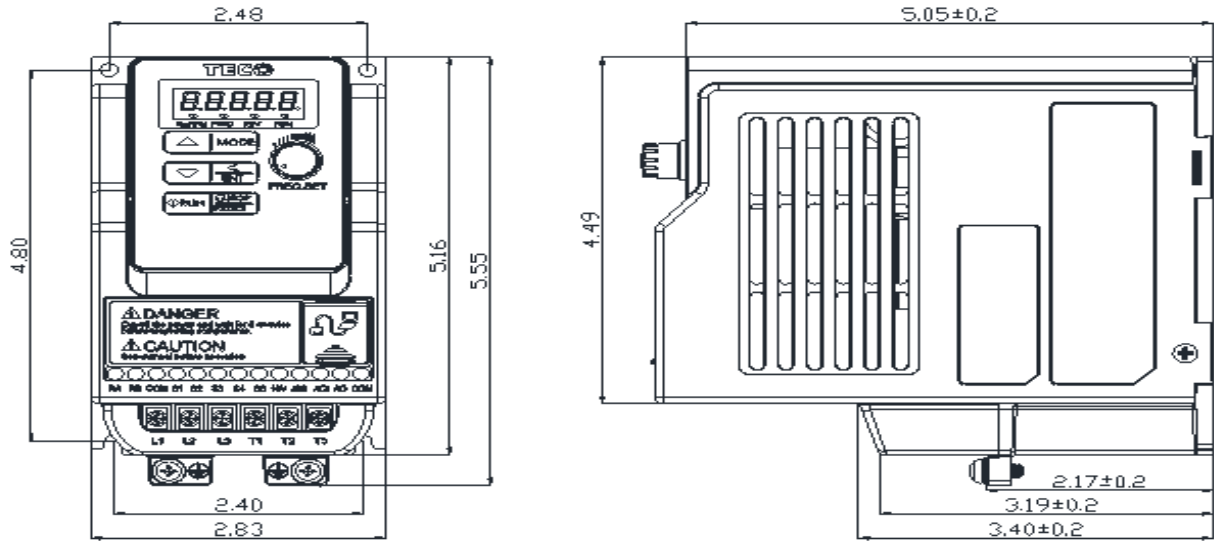

Approved By:	Brian Smith	Drawing No:	L510-230-201-F1	Revision: 1
--------------	-------------	-------------	-----------------	-------------