

GENERAL DATASHEET VARIABLE SPEED DRIVE

SERIES F510		MODEL# F510-2003-C-UE		
ISSUED 2/10/2020		ENCLOSURE/ FRAME NEMA 1 (IP20) / F1		
SINGLE PHASE INPUT AMPS ND (VT) 19.6		AC INPUT VOLTAGE 200-240	AC INPUT FREQUENCY 50/60	AC INPUT PHASE 1/3
THREE PHASE INPUT AMPS ND(VT) 11.4				
OUTPUT HP ND (VT) 3	OUTPUT AMPS ND (VT) 10.6	AC OUTPUT VOLTAGE 0-240	AC OUTPUT FREQUENCY 0-400	AC OUTPUT PHASE 3

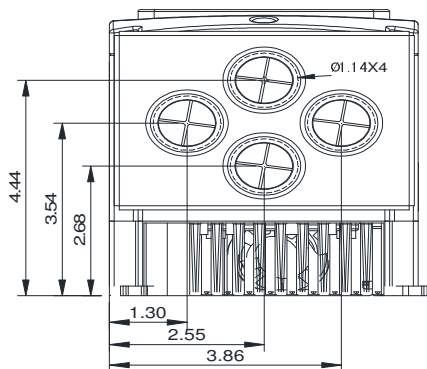
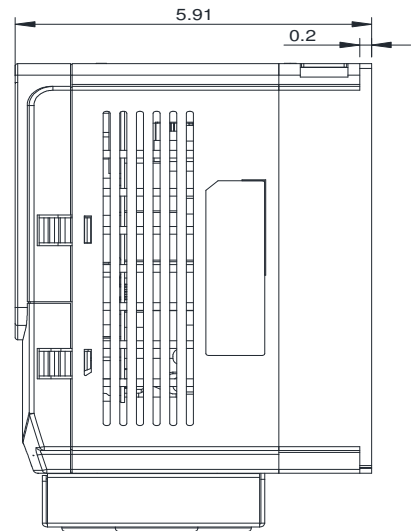
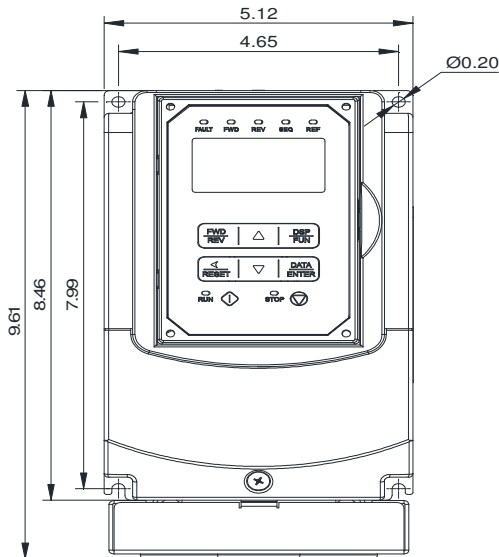

Approved By:	Brian Smith	Drawing No:	F510-230-003-F1	Revision: 1
--------------	-------------	-------------	-----------------	-------------